

LINC MODELL 2

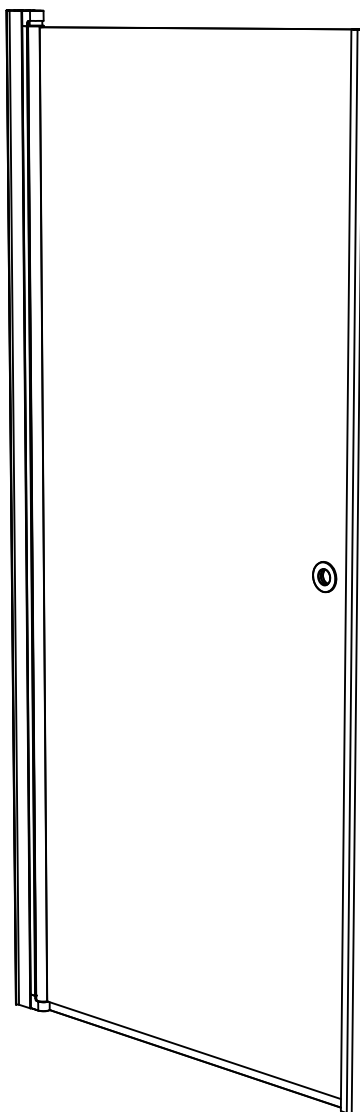

140306A



Produkten är anpassad till branschregler Säker Vatteninstallation. INR garanterar produktens funktion om branschreglerna och monteringsanvisningen följs.

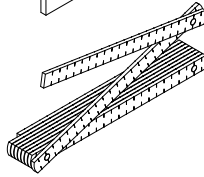
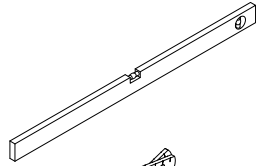
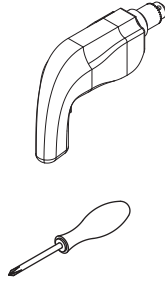
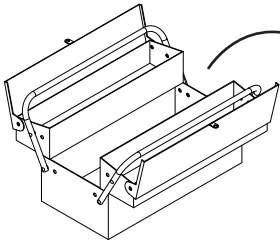

x 1

Eller
Or



x 1

Vid behov
When needed

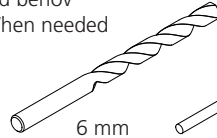

6 mm

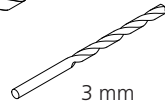

3 mm



x 4

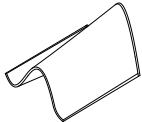

x 1



x 1



2.5 mm x 1



x 2

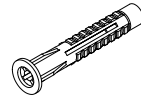

x 3



x 2



x 1

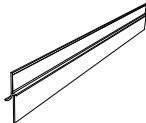

x 1

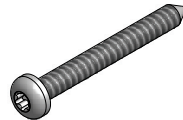

x 3



x 2

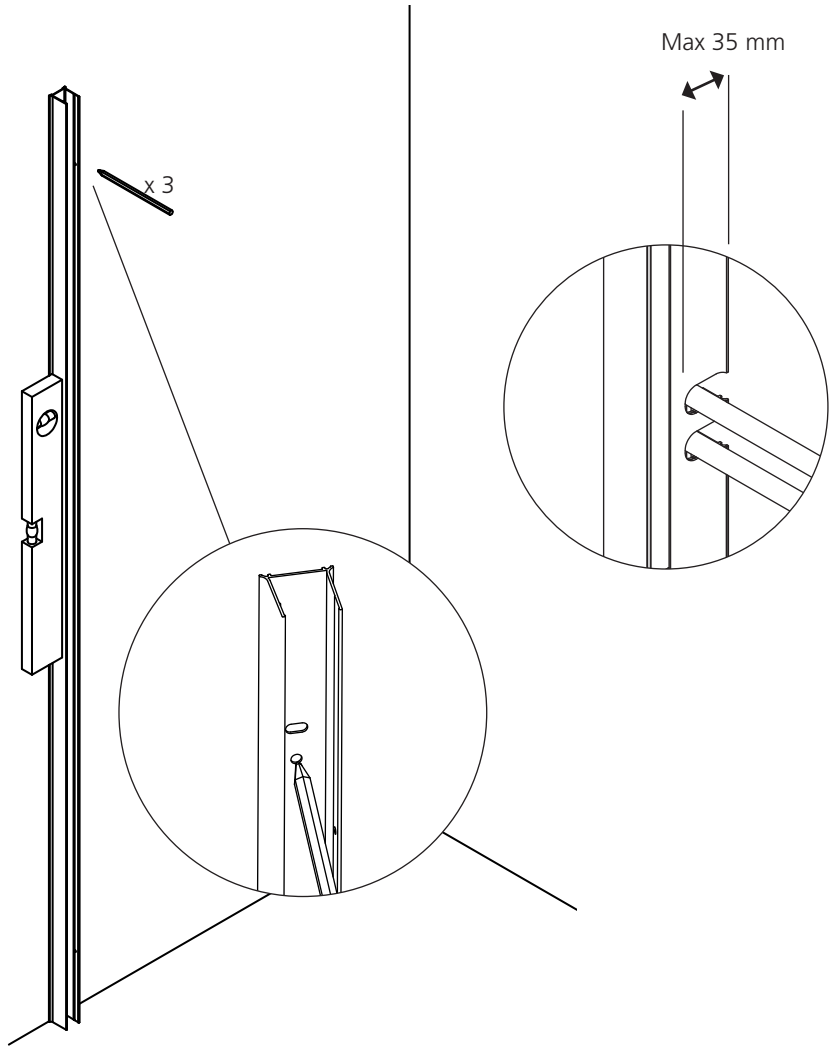

2

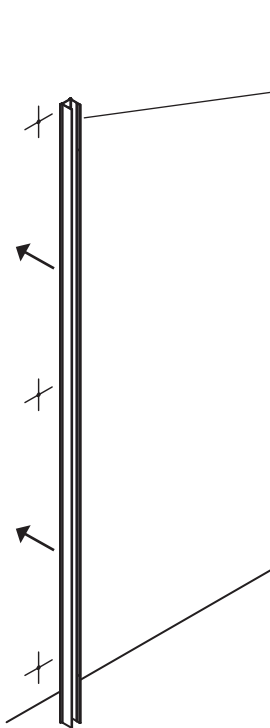

Hålen på insidan av duschen
Holes on inside of shower

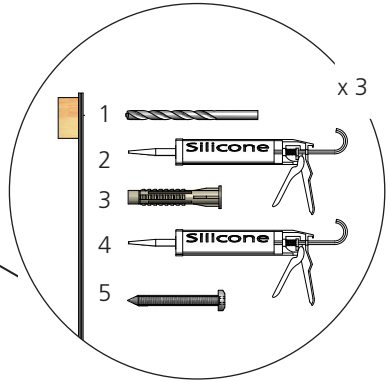
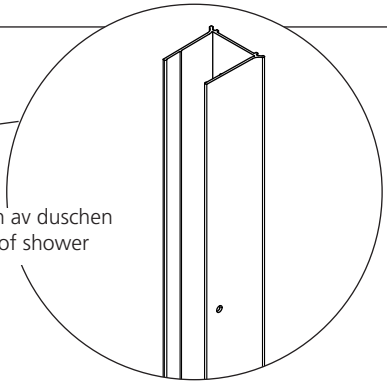

3

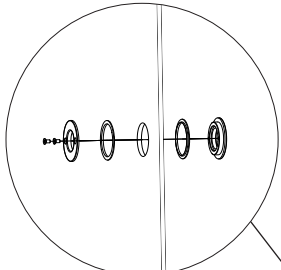

Eller
Or

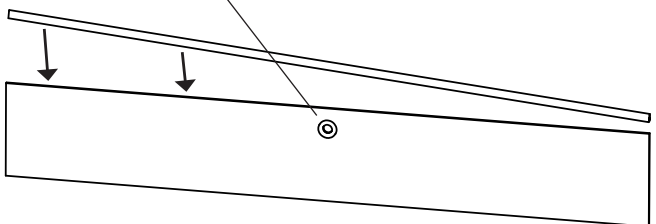
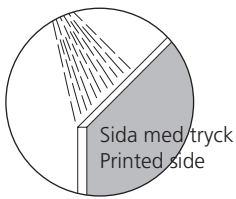
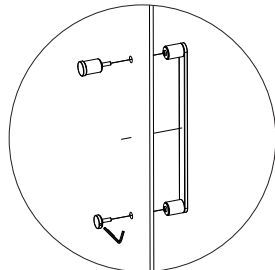

4

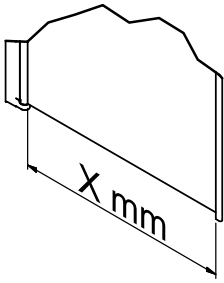

Mät
Measure

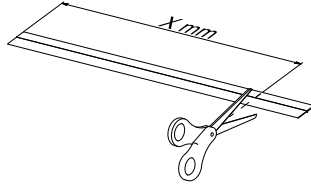

Klipp
Cut

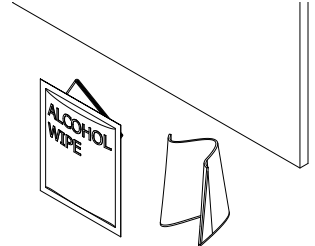

1. 2.

Rengör noggrant och torka torrt
Clean thoroughly and wipe dry

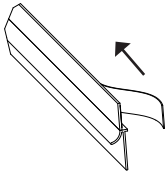

Avlägsna remsan
Remove strip

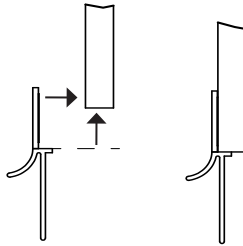

Applicera
Apply

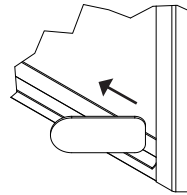

Tryck till
Press thoroughly

Vänta 24 h
Wait 24 h

5

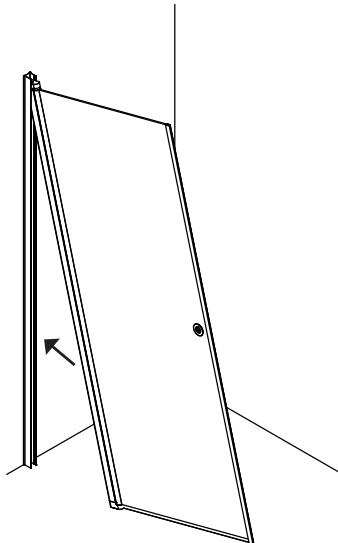

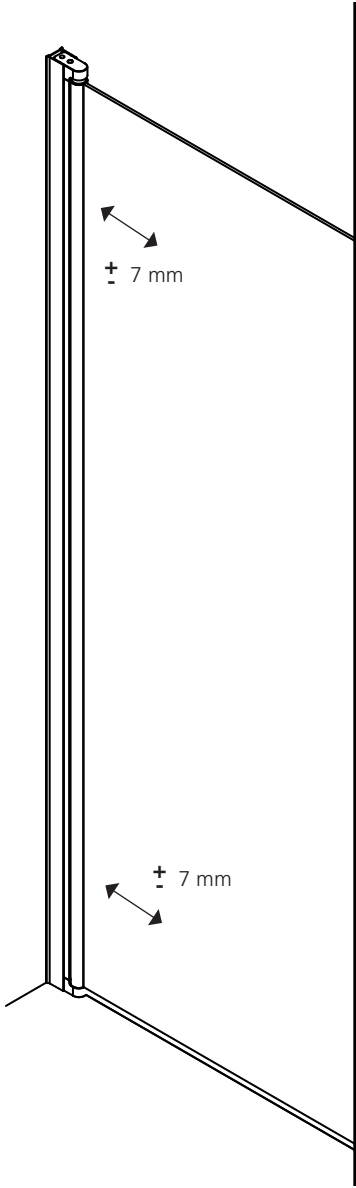

7

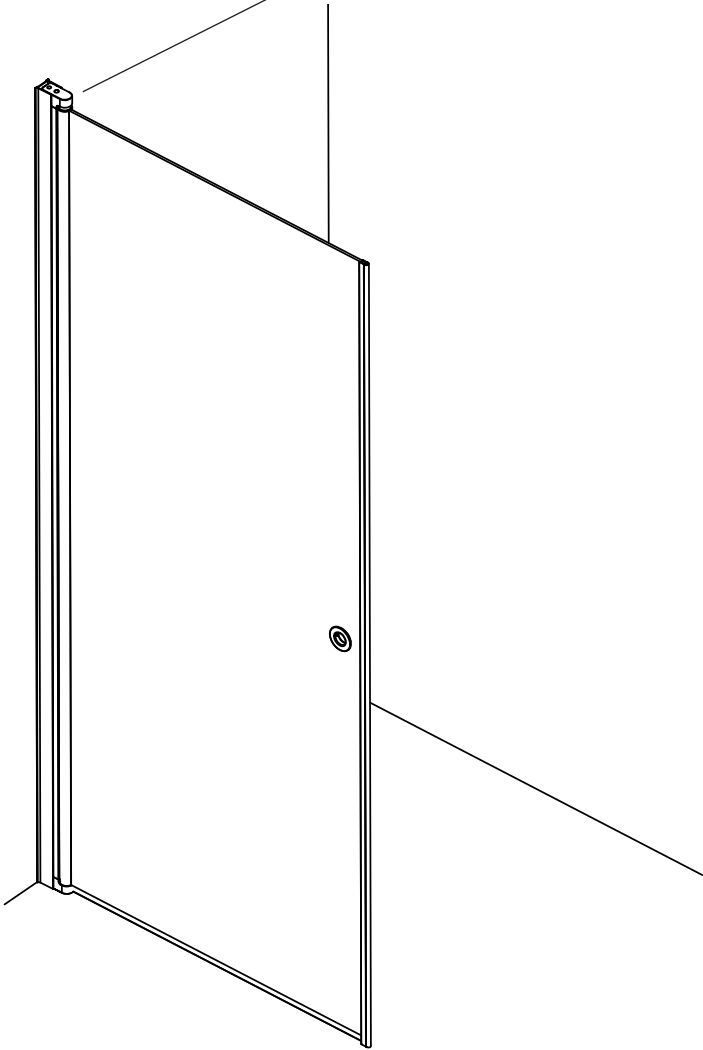
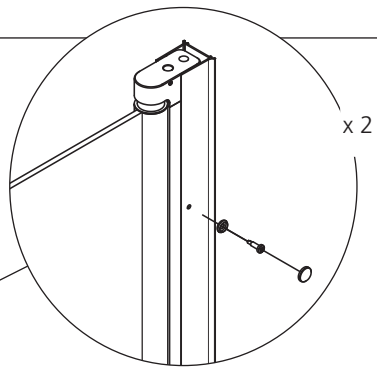

SV

ORÄTVINKLIGT MONTAGE OCH INSTÄLLNING AV LYFTFUNKTION

Vid orätvinkligt montage eller då glaset inte stannar ihop vid stängning, gör följande: Lossa setskruven i botten på lyftgångjärnet. Justera dörren till önskat nolläge. Spänn skruven.

SKÖTSELRÅD

Renör dagligen duschväggen med vatten och gummiskrapa. Mot ingrodd smuts rekommenderas ättiksbaseerade rengöringsmedel. Tänk på att svampar och rengöringspasta med slipmedel kan repa såväl glas som metall.

ÅTERVINNING

1. Använd skyddsglasögon och handskar.
 2. Separera rundstång med glas från lyftgångjärn genom att lossa de två skruvarna upp och nertill.
 3. Ta bort plast-, aluminiumdetaljer och skruvar från rundstångens ändar.
 4. Separera tätningslisterna från glaset.
 5. Lägg ut någon form av skydd under glaset.
 6. Knacka på ena hörnet med en hammare så att det går sönder.
 7. Skrapa bort resterande glas från rundstången med skruvmejsel.
- Glas lämnas till glasåtervinning.
 - Aluminium lämnas till metallåtervinning.
 - Plastlister och andra plastdetaljer lämnas till plaståtervinning.

EN

NON-PERPENDICULAR INSTALLATION AND ADJUSTING THE LIFT FUNCTION

In the event of non-perpendicular installation or when the sheets of glass do not remain together when closing, proceed as follows. Locate the set screw at the bottom of the lifting hinge. Carefully screw anti-clockwise with an Allen key. Adjust the glass to the desired zero position and retighten the screw.

CARE ADVICE

Clean daily with water and a squeegee. To combat ingrained dirt, you are recommended to use a vinegar-based detergent. Remember that sponges and abrasive paste cleaners can scratch both the glass as well as metal.

RECYCLING

1. Wear protective goggles and gloves.
 2. Separate the round bar with the glass from the hinge by undoing the two locking screws top and bottom.
 3. Remove all plastic and aluminium components and the screws from the ends of the round bar.
 4. Separate the sealing strip from the glass.
 5. Place some form of protection under the glass.
 6. Strike one corner with a hammer to break the glass.
 7. Scrape away the remaining glass from the round bar with a screwdriver.
- Take glass to the glass recycling facility.
 - Take aluminium and screws to the metal recycling facility.
 - Take plastic strips and components to the plastic recycling facility.